



Oprawki bakelitowe ZMONTOWANE

PRODUKT POLSKI 

Oprawka bakelitowa E27 z metalowym wkładem M10x1 i terminalem zaciskowym - śrubowym

----- Dostępna kolorystyka -----



----- Na zamówienie -----





5050R

5055R

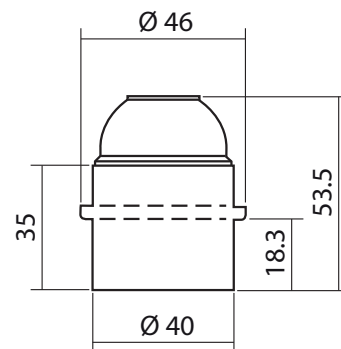
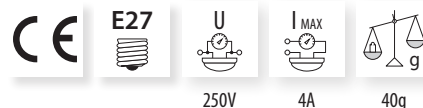
5057R



	Nazwa produktu	
5050R	Oprawka E27 z obudową gładką	50
5055R	Oprawka E27 z obudową gwintowaną	50
5057R	Oprawka E27 z obudową częściowo gwintowaną	50

Oprawka bakelitowa E14 z metalowym wkładem M10x1 i terminalem zaciskowym - śrubowym

----- Dostępna kolorystyka -----



----- Na zamówienie -----





5070R

5075R

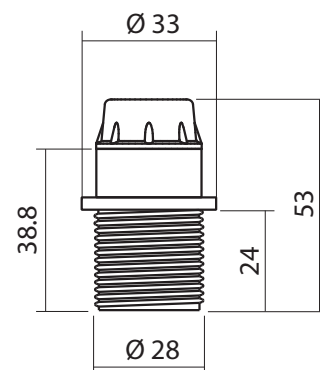
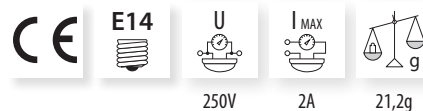
5077R



	Nazwa produktu	
5070R	Oprawka E14 z obudową gładką	100
5075R	Oprawka E14 z obudową gwintowaną	100
5077R	Oprawka E14 z obudową częściowo gwintowaną	100

Oprawki bakelitowe NIEZMONTOWANE

PRODUKT POLSKI 

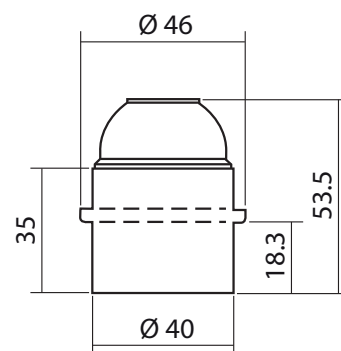
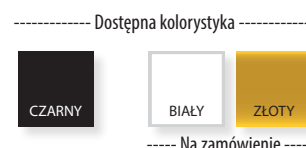

Oprawka bakelitowa E27 serii 7000 z metalowym wkładem M10x1 i terminalem zaciskowym - śrubowym.

KOMPONENTY W 3 ODDZIELNYCH OPAKOWANIACH.



Obudowa E27, gładka



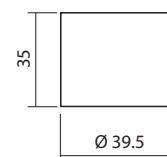

		
CAM/7175/E	18,4g	1000



Obudowa E27, gwintowana



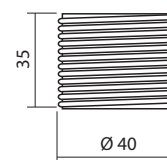

		
CAM/7200/E	17g	1000



Obudowa E27, gwint do połowy



		
CAM/7350/E	21,1g	1000

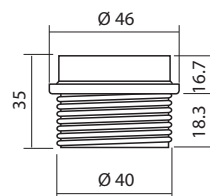





Oprawki bakelitowe NIEZMONTOWANE

PRODUKT POLSKI 

Terminal zaciskowy, śrubowy



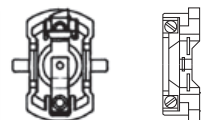

 INDEX				
PST/7000/M1	250V	4A	40g	100



Czapka



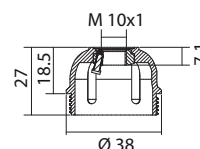

 INDEX		
CAP/7000	14,5g	1000



Czapka z terminalem uziemiającym



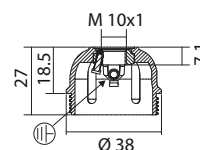

 INDEX		
CAP/7000/T	17,5g	1000



Czapka z otworem bocznym Ø7



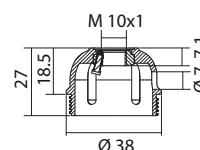

 INDEX		
CAP/7000/F	16,3g	1000





Czapka z otworem bocznym Ø7 i terminalem uziemiającym

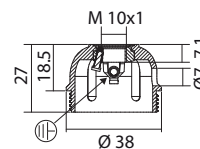

 INDEX		
CAP/7000/T/F	16,6g	1000



Czapka wysoka

 INDEX		
CAP/7000/H	20g	25

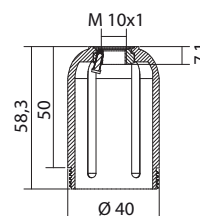

Oprawki bakelitowe z przełącznikiem NIEZMONTOWANE

PRODUKT POLSKI 

**Oprawka bakelitowa E27 serii 7000/H4
z metalowym wkładem M10x1
i przełącznikiem kołkowym.**
KOMPONENTY W 1 OPAKOWANIU ZBIORCZYM.



----- Dostępna kolorystyka -----



----- Na zamówienie -----



5090

5091



5092

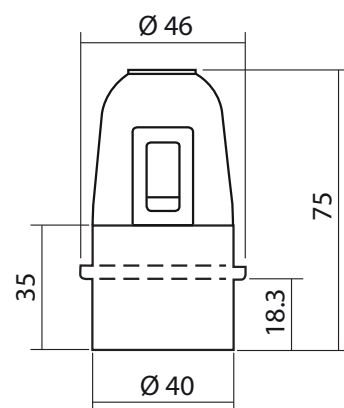

250V

2A



	Nazwa produktu	 g	
5090	Oprawka 7000/H4 z obudową gładką	57,4g	25
5091	Oprawka 7000/H4 z obudową gwintowaną	56,5g	25
5092	Oprawka 7000/H4 z obudową częściowo gwintowaną	60,1g	25

**Oprawka bakelitowa E27 serii 7000/HT
z metalowym wkładem M10x1
i przełącznikiem sznurkowym.**
KOMPONENTY W 1 OPAKOWANIU ZBIORCZYM.



----- Dostępna kolorystyka -----



----- Na zamówienie -----



5093

5094

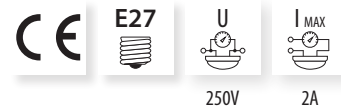

5095

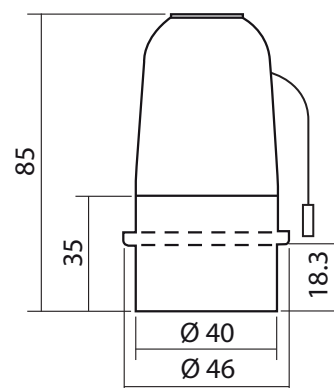

250V

2A



	Nazwa produktu	 g	
5093	Oprawka 7000/HT z obudową gładką	68,1g	25
5094	Oprawka 7000/HT z obudową gwintowaną	67,2g	25
5095	Oprawka 7000/HT z obudową częściowo gwintowaną	70,8g	25

Oprawki bakelitowe ZMONTOWANE



PRODUKT POLSKI 

Oprawka bakelitowa E27 do łańcuchów oświetleniowych z zaciskami przebijającymi izolację

Dostępna kolorystyka

CZARNY



IP44

*



40W



250V



4A



32,4g



H05RN2-F



2x1,5mm²

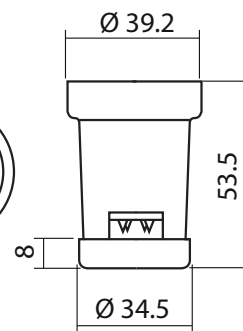
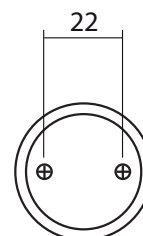

Nazwa produktu



DU/5727	Oprawka E27 do łańcuchów oświetleniowych ze śrubami specjalnymi	500
DU/5727/VV	Oprawka E27 do łańcuchów oświetleniowych	500

* IP44 dla opravek z wklejoną uszczelką 393/A/N (sprzedawaną oddzielnie)

Uszczelka 393/A/N*



Nazwa produktu



g



393/A/N	Uszczelka do opravek DU/5727 i DU/5727VV	4,8g	500
---------	--	------	-----

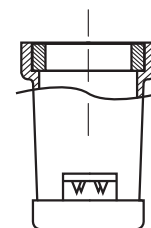
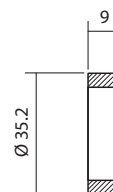

* uszczelkę osadzić na kleju silikonowym



Oprawki bakelitowe NIEZMONTOWANE

PRODUKT POLSKI 

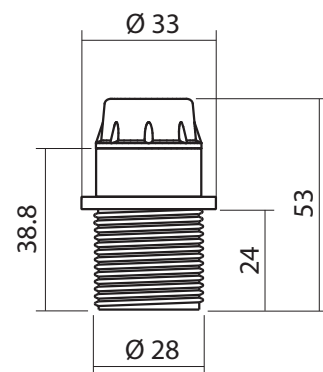

Oprawka bakelitowa E14 serii 3000 z metalowym wkładem M10x1 i terminalem zaciskowym - śrubowym.

KOMPONENTY W 3 ODDZIELNYCH OPAKOWANIACH.



Obudowa E14, gładka





		
CAM/3175/E	13g	1500



Obudowa E14, gwintowana



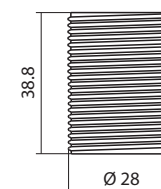

		
CAM/3200/E	13g	1500



Obudowa E14, gwint do połowy



		
CAM/3250/E	14,5g	1500

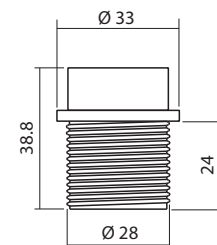





Oprawki bakelitowe NIEZMONTOWANE

PRODUKT POLSKI 

Terminal zaciskowy E14, śrubowy



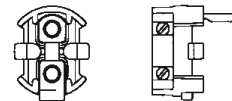

 INDEX				
PST/3000/M1	250V	2A	3,2g	1500



Czapka



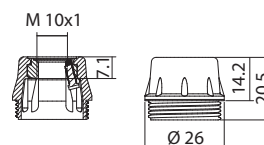

 INDEX		
CAP/3000	8,3g	1500



Czapka z otworem bocznym Ø6



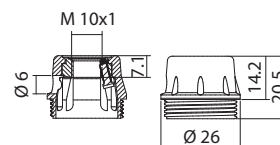

 INDEX		
CAP/3000/F	9,1g	1500



Czapka wysoka



 INDEX		
CAP/3000/H19	10,4g	1500

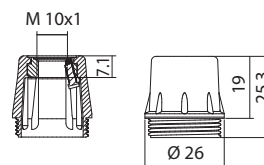

Pierścienie termoplastyczne do oprawek bakelitowych



----- Dostępna kolorystyka -----



----- Na zamówienie -----

Pierścień termoplastyczny Ø58



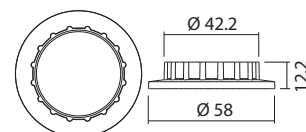

 INDEX		
D/73P/N	6,3g	1000



Pierścień termoplastyczny Ø43



 INDEX		
D/31P/N	3,5g	1000

